

# On Acoustic Vibration Transformation for Low Level Vibrations

Sirasala Seetharamudu

Assistant Professor, Department of Electrical Engineering, Santhiram Engineering College, Nandyal, Krmool (D.T) Andhra Pradesh, India

**Abstract**— In the past few years good research has been carried on the energy harvesting systems. Energy harvester system is based on the transformation of acoustic vibrations into electrical energy. This harvested energy is being used for niche applications because of its reduced power consumption in modern day electronic systems. Vibration is one of the better ways in terms of quality power and is considered to be efficient among other ambient energy sources, such as solar energy and Temperature difference. Piezoelectric and electromagnetic devices are mostly used in conversion of vibrations to ac electric power. This input stress/vibration power can be generated by machines, humans and its frequency is generally in the range of Hz to KHz. These vibrations are practically available in the form of different noises. This paper gives an introduction to energy harvesting fundamentals, analysis of low level acoustic vibration transformation to electrical power have been described through simulation results and Comparison of harvested power through different levels of vibrations in form of noise inputs are also presented.

**Keywords**— *Vibratory energy harvester, piezo electric generator, transducer, BLWN, Gaussian*

## I. INTRODUCTION

Energy recovery from waste or unused power has been a topic of discussion in recent times. Unused power exists in various forms such as industrial machines, human activity, vehicles, structures and environment sources. Among these, some of the promising sources for recovering energy are periodic vibrations generated by rotating machinery or engines. In recent years, several energy harvesting approaches have been proposed using solar, thermoelectric, electromagnetic, piezo electric. Table I provides the list of power requirement for various household electronic devices. The cell phone (stand by) or T.V remote requires a small power level of 35 and 100 mW. These magnitudes of power are possible to be continuously harvested from human and industrial activity.

A large network with several sensor nodes and data acquisition components requires a centralized energy source that has to be charged or replaced over time. In remote applications such as structural health monitoring of aircrafts or ships, recharging, battery replacement or wiring can be very tedious and expensive task.

In many other cases, these operations may be prohibited by the infrastructure. Further, in order for the sensor nodes to be conveniently placed and used they should be as small as possible which puts an upper limit on their life time.

There are four possible ways to realize a distributed sensor network with adequate performance as following

- enhance the energy density of the storage system
- reduce the power consumption of the sensor
- develop self powered sensors by generating or harvesting energy
- Transmit the power from a centralized source to the sensor.

Out of these various possible solutions the most efficient and practical method is to develop self-powered sensors by harvesting energy from the wasted energy.

TABLE I. AVERAGE POWER CONSUMPTION OF HOUSEHOLD DEVICES [1]

Source Device	Consumption of power (P avg)
FM radio	30mW
Walk man (in play mode)	60mW
TV remote	100mW
Mobile(talk/stand by)	2W/35mW
Torch light	4W
LAPTOP	10W

Next the main type of energy harvester is solar energy. It is a very attractive source for powering sensor networks and the

solar technology has matured over the years. One of the major challenges in the implementation of solar technology on “energy on demand” platforms has been the requirement of bulky electronics.

Further, the variation in light intensity (out door vs. indoor) can drop the efficiency significantly as shown in Table II. Also, the solar power drops down significantly inside the building. The other most attractive source is kinetic energy comprising of mechanical vibrations, air flow and human power. The kinetic energy can be converted into electric energy using piezoelectric, electromagnetic or electrostatic mechanism.

It can be easily shown that piezoelectric transducers are more suitable as kinetic to electrical energy converters. In addition to the advantage of being smaller and lighter the piezoelectric have three times higher energy density as compared to their counterparts electrostatic and electromagnetic.

This paper presents the details of electric conversion mechanism in section II than theory of vibration sources in section III. Section IV presents the basic electrical equivalent for mechanical model of energy harvester than details of general diagram of generator based vibrations energy harvesting in section V. Section VI details the experimental results through simulation work. Section VII gives the conclusion of the experimental work of energy harvester.

TABLE II. COMPARISON OF THE HARVESTED POWER FOR DIFFERENT TYPES OF ENERGY SOURCES TO ELECTRICAL ENERGY CONVERTERS [2]

Energy Source	Characteristics	Efficiency	Harvested Power
Light	Outdoor	10~24%	100mW/cm <sup>2</sup>
	Indoor		100 μW/cm <sup>2</sup>
Thermal	Human	~0.1%	60 μW/cm <sup>2</sup>
	Industrial	~3%	~1-10mW/cm <sup>2</sup>
Vibration	~Hz–human	25~50%	~4 μW/cm <sup>3</sup>
	~kHz–machines		~800 μW/cm <sup>3</sup>
RF	GSM 900MHz	~50%	0.1 μW/cm <sup>2</sup>
	Wi Fi		0.01 /cm <sup>2</sup>

II. VIBRATION TO ELECTRIC CONVERSION MECHANISM

For conversion of vibration energy into electrical energy Williams and Yates[3] have proposed a generalized model as shown in Figure 1. The basic assumption of the model is that the mass of the vibration source is much greater than the seismic mass in the generator, and that the vibration source is an infinite source of power.

The differential equation of motion describing the system in terms of the housing vibration (V(t) = V<sub>0</sub> cos ωt) and relative motion of mass (X(t)) is given as:

$$m_g \ddot{X}(t) + d_g \dot{X}(t) + k_g X(t) = -m_g \ddot{V}(t) \quad (1)$$

Where,

m<sub>g</sub> is the mass of the system,

d<sub>g</sub> is the damping constant and

k<sub>g</sub> is the spring constant.

The total power dissipated in the damper under sinusoidal excitation was found to

$$P(\omega) = \frac{m_g \zeta V_0^2 (\frac{\omega}{\omega_n})^3 \omega^3}{[1 - (\frac{\omega}{\omega_n})^2]^2 + [2\zeta (\frac{\omega}{\omega_n})]^2} \quad (2)$$

Where,  $\omega_n^2 = k_g / m_g$ ,

ω<sub>n</sub> is the system resonant frequency.

ζ = d<sub>g</sub> / 2√k<sub>g</sub>m<sub>g</sub>,

ζ is the damping ratio.

In case of resonance condition, the vibration spectrum is known that the device can be tuned to operate at the resonance frequency (ω<sub>r</sub>) of the system, in this case the maximum power that can be generated is given as:

$$P_{max} = \frac{m_g V_0^2 \omega_n^3}{4\zeta} \quad (3)$$

Equation (3) implies that the power is inversely proportional to the damping ratio which should be minimized through proper selection of the materials and design. The loss factors (roughly equal to 2ζ) for some commonly used structural materials are quite small, e.g., aluminium 0.007 and steel 0.05.

In terms of the acceleration the above expression can be written as,

$$P_{max} = \frac{m_g * a^2}{4\omega_n \zeta} \quad (4)$$

Where,

$$a = V_0 * \omega_n^2$$

‘a’ is the acceleration constant. This implies that output power is proportional to the square of the acceleration.

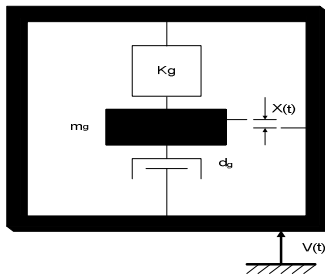

Fig. 1: Schematic of Piezoelectric Generator [1]

Another important conclusion that can be drawn from Equation.4 is that output power is directly proportional to the proof mass of the system and thus reducing the size of the converter reduces the conversion efficiency

III. THEORY OF VIBRATION SOURCES

The sources of vibrations are widely available in nature like from human , machines and most of the vibrations measured from commonly available sources as shown in Table III[4].

TABLE III . ACCELERATION AND FREQUENCY FOR DIFFERENT VIBRATION SOURCES [4]

SOURCES OF VIBRATIONS	Max acceleration (m/ s <sup>2</sup> )	peak frequency(HZ )
Engine of car(start)	12	200
Human walk(foot)	3	1
Door frame(just after close)	3	125
Second story floor of busy office	0.2	100

This Table III gives the information about the vibration sources measured in terms of the frequency and acceleration magnitude of the mode of vibration. Those vibrations in low level frequency, so it called low level vibrations. By using energy harvester model can convert this vibration energy in to useful electric energy

According to Viennese Reichsbruke Figure.2 [5] shows the vibration spectrum for human walking and running conditions. Figure.2a shows the vibration spectrum for the human marathon (running) and Figure.2b, for the persons walking or crossing the road at the regular traffic system. The above graphs shows the acceleration (m/s<sup>2</sup>) vs frequency from this when human in marathon condition, getting maximum acceleration at frequency of 2.5HZ.and in normal walking case maximum acceleration at frequency of 6.5 HZ.

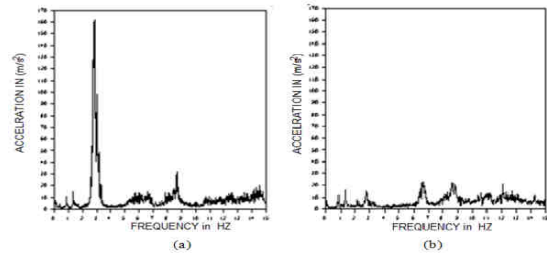

Fig. 2: (A) Vibration Spectra For Human Marathon (Running) (B)Vibration Spectra For Human Walking (In Regular Traffic) [5]

IV. ELECTRICAL EQUIVALENT FOR MECHANICAL MODEL

The iota power generated by the converter is measured across the electrical load. In order to analyze the frequency response of the electromechanical system it is easier to perform the analysis using the equivalent circuit model. Table IV [1] lists the analogy between the mechanical and electrical parameters that can be used to derive the equivalent circuit for a given mechanical system.

TABLE IV CONVERSATION EQUIVALENCE BETWEEN ELECTRI CAL ANDME CHANIC AL PARAMETRS [1]

Electrical parameter	Mechanical parameter
Voltage(v)	Force(N)
Current(A)	Velocity(m/s)
Resistance(Ω)	Damping(N-s/m)
Inductor(H)	Mass(Kg)
Capacitor(F)	Compliance(m/N)

The dimension of mechanical impedance is same as that of mechanical resistance and is expressed in the same unit, N·s/m, often defined as mechanical ohms. Figure3 [1] shows the electrical equivalent circuit of the vibration source and elastic load. These equivalence relations can use in analyzing the performance of the system

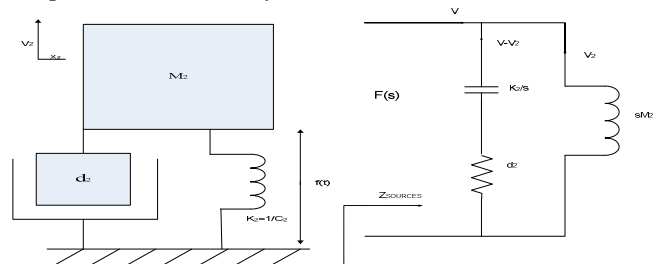

Fig.3:A Electrical Equivalence of the Mechanical System of Vibration Source

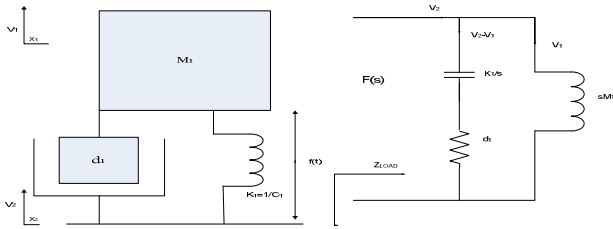

Fig.3: B Electrical Equivalence of the Mechanical System of Elastic Load

In the off-resonance condition the modeling of the generator can be significantly simplified as illustrated in Figure 4. Figure 4a shows the schematic of the piezoelectric bimorph transducer of height H, length L and width W subjected to the AC force F. The load dependence of the bimorph in the frequency range far from the resonance can be computed by using the equivalent circuit representation shown in Figure 4b.

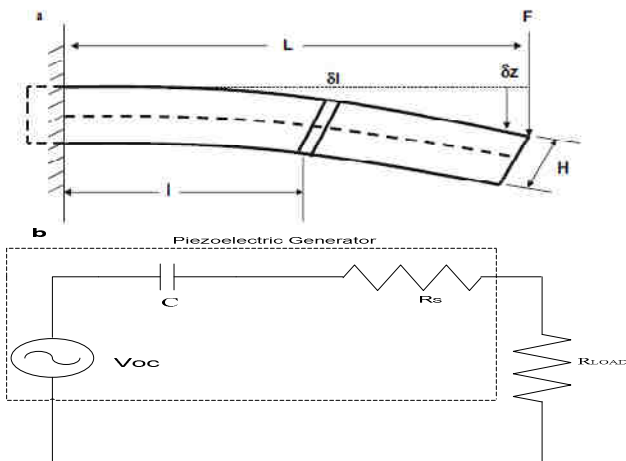

Fig. 4: Schematic of the Model for the Piezoelectric Bimorph. A) Strain In A Bent Rectangular Section Cantilever For Width W And Thickness H [1]

B) Equivalent Circuit Representation Of The Piezoelectric Generator In Off-Resonance Condition

In this circuit the voltage source is taken to be the open circuit voltage across the bimorph. The voltage across the load can then be expressed as [6]:

$$V_{Load} = V_{OC} \left| \frac{R_{Load}}{R_{Load} + \frac{1}{j\omega C} + R_S} \right| \quad (5)$$

Where  $R_S$  is the series resistance ( $R_S = \frac{\tan \delta}{2\pi f C}$ ) and C is the damped capacitance of the bimorph. The average power delivered to the load can then be found using the expression:

$$P = \frac{V_{Load}^2}{2R_{Load}} \quad (6)$$

The power reaches maximum at an optimum load which for the equivalent circuit shown in Figure. 4b is given as:

$$R_{Load}^{opt} = \left| R_S + \frac{1}{j\omega C} \right| \quad (7)$$

## V. GENERAL DIAGRAM OF GENERATOR BASED VIBRATIONS ENERGY HARVESTING

The piezoelectric transducer converts vibration signal to useful electric output. Figure.5 shows the general diagram of generator based vibrations energy harvesting using piezoelectric material.

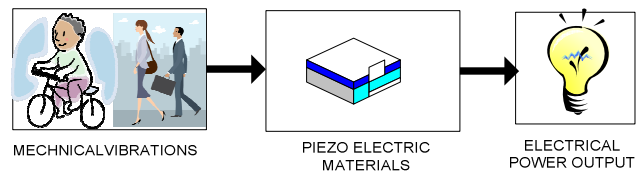

Fig. 5 General Diagram of Generator Based Vibrations Energy Harvesting Using Piezoelectric Material [7]

## VI. EXPERIMENTAL RESULTS AND DISCUSSION

### A. Analysis Of Different Vibration With Simulation Result

In this analysis the vibrations in form of noises & characteristics of the vibrations, by applying those vibration signal input to electrical equivalent of mechanical model or piezoelectric transducers.

Those vibrations or noises are

- Band limited white noise
- Gaussian noise
- Rayleigh noise
- Rician noise

The electrical responses of the parallel type piezo electric model for different noise input are observed. Figure.6. shows the Electrical equivalent of parallel type piezoelectric module with vibration input.

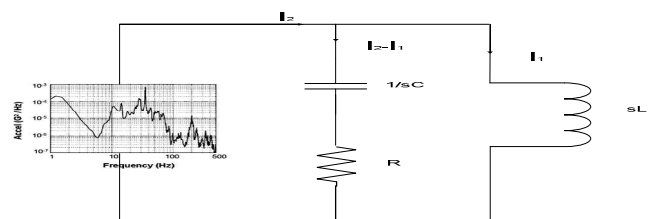

Fig. 6: Electrical Equivalent Of Parallel Type Piezoelectric Module With Vibration Input

To analysis the different noises & compared with the each response of those noises. Figure. 7.shows the simulink module of piezo electric module. For the BLWN noise as a input and the module have lumped parameters  $R=177K\Omega$ ,  $L=330\mu H$ ,  $C=5pF$  and it gives maximum response at frequency 99 Hz , in terms of converted power 2.1 nano watts and generated voltage 3.25v . In case of low frequency range (1 to 15 Hz) the maximum response at frequency 8 Hz, in terms of converted power 1.9 nano watts and 3.1 volts

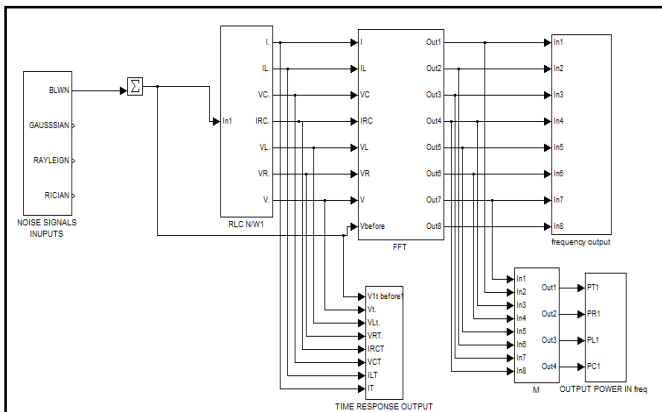

Fig. 7: Simulink Module of Piezo Electric Module

In case of Rician noise as a input for the module it generates better output responses at frequency 99 Hz compare to remaining noise inputs. The output responses in terms of converted power 6.6nano watts and voltage 5.95volts. Table V shows the Comparison of Different Noises with Maximum Values.

In graphical manner Figure.8shows the Comparison of Different Noise power Responses for Parallel Type Piezoelectric Module with  $R=177K\Omega$ ,  $L=330\mu H$ ,  $C=5pF$

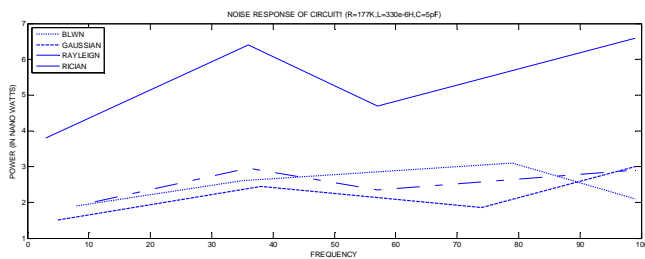

Fig. 8: Comparison Of Different Noise Power Responses For Parallel Type Piezoelectric Module With  $R=177K\Omega$ ,  $L=330\mu H$ ,  $C=5pF$

TABLE V COMPARISON OF DIFFERENT NOISES WITH MAXIMUM VALUES

Type of noise generator	Maximum values of (1 to 100)HZ			Maximum values of (1 to 15)HZ		
	Frequency	Voltage	Power (nanowatts)	Frequency	Voltage	Power (nanowatts)
BLWN	99	3.25	2.1	8	3.1	1.9
GAUSSIAN	99	3.9	3	5	2.75	1.5
RAYLEIGN	99	3.9	2.9	11	3.2	2.02
RICIAN	99	5.95	6.6	3	4.3	3.8

TABLE VI. COMPARISON OF DIFFERENT NOISES WITH MAXIMUM VALUES

Type of noise generator	Maximum values of (1 to 100)HZ			Maximum values of (1 to 15)HZ		
	Frequency	Voltage	Power ( $\mu$ watts)	Frequency	Voltage	Power ( $\mu$ watts)
BLWN	99	3.3	0.31	8	3.15	0.27
GAUSSIAN	99	3.95	0.445	5	2.78	0.21
RAYLEIGN	99	3.96	0.3	11	3.23	0.19
RICIAN	99	6	0.64	3	4.38	0.26

The response of parallel type piezo electric module for different type coil parameters. For coil 2 output values is shown in Table VI. In graphical manner Figure. 9 shows the Comparison of Different Noise power Responses for Parallel Type Piezoelectric Module with  $R=580K\Omega$ ,  $L=680\mu H$ ,  $C=750pF$

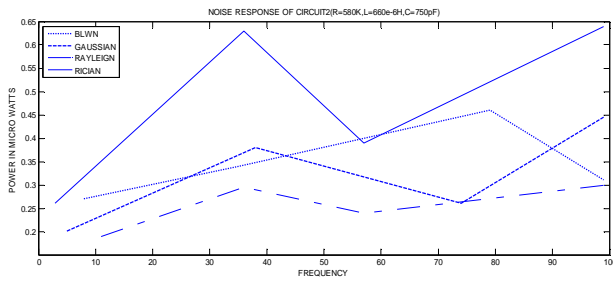

Fig. 9: Comparison of Different Noise Power Responses for Parallel Type Piezoelectric Module With  $R=580K\Omega$ ,  $L=680\mu H$ ,  $C=750Pf$

The response of parallel type piezo electric module for different type coil parameters. For coil 3 output values is shown in Table VIII in graphical manner Figure. 10 shows the Comparison of Different Noise power Responses for Parallel Type Piezoelectric Module with  $R=0.02368\Omega$ ,  $L=1mH$ ,  $C=190\mu F$

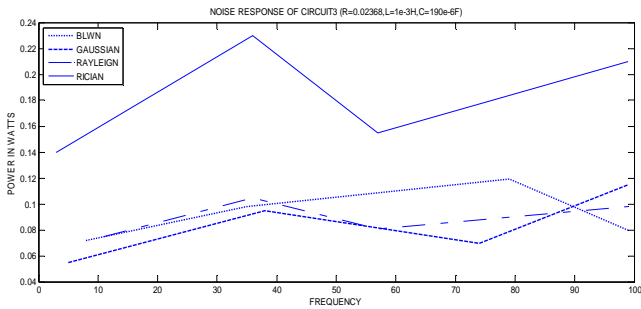

Fig. 10: Comparison Of Different Noise Power Responses Of Parallel Type Piezoelectric Module With  $R=0.02368\Omega$ ,  $L=1mH$ ,  $C=190\mu F$

TABLE VII. COMPARISON OF DIFFERENT NOISES WITH MAXIMUM VALUES

Type of noise generator	Maximum values of (1 to 100)HZ			Maximum values of (1 to 15)HZ		
	Frequency	Voltage	Power (in watts)	Frequency	Voltage	Power (in watts)
BLWN	99	3.25	0.08	8	3.1	0.072
GAUSSIAN	99	3.9	0.115	5	2.7	0.055
RAYLEIGN	99	3.9	0.098	11	3.2	0.075
RICIA	99	5.9	0.21	3	4.35	0.14



Fig. 11: Series Type Piezoelectric Module

The parallel type piezo electric module with coil 3 generating good range of power and voltage compare to remaining two coils. By observing the Figure.10, Rician noise is suitable for analysis of high power range responses. Gaussian and Rayleigh noises are suitable for analysis of medium power range responses for low power range analysis the BLWN is suitable. For the analysis of noise apply the noise input to series type piezo electric module, it shown in Figure. 11.

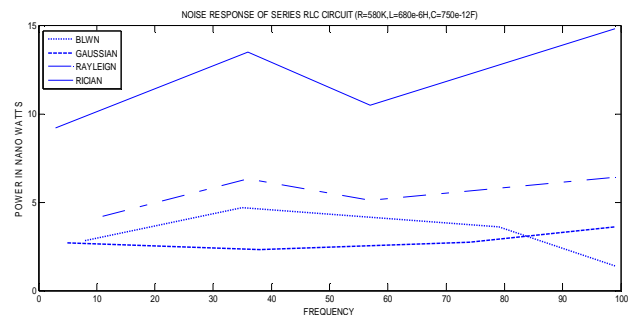

Fig. 12: Comparison Of Different Noise Power Responses For Series Type Piezoelectric Module With  $R=580K\Omega$ ,  $L=680\mu H$ ,  $C=750pF$

The responses of series type piezo electric module with coil2 parameter are shown in Figure. 12. The output response value of series type piezo electric module is shown in Table VIII.

TABLE VIII. COMPARISON OF DIFFERENT NOISES WITH MAXIMUM VALUES

Type of noise generator	Maximum values of (1 to 100)HZ			Maximum values of (1 to 15)HZ		
	Frequency	Voltage	Power (nanowatts)	Frequency	Voltage	Power (nanowatts)
BLWN	99	3.25	1.4	8	3.1	2.85

GAUSSIAN	99	3.9	3.6	5	2.7	2.7
RAYLEIGH	99	3.95	6.4	11	3.2	4.2
RICIAN	99	5.9	14.8	3	4.3	9.2

resistance 6725KΩ delivered the highest power output of 145pico watts as shown in Table IX .In graphical manner Figure.14 shows the Comparison of various  $R_L$  values power Responses for Piezoelectric generator Module with  $R=580K\Omega$ ,  $C=750pF$ .

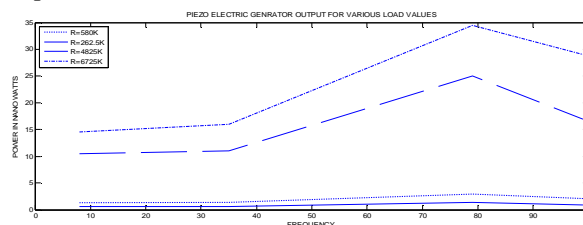

Fig.14: Comparison of various  $R_L$  values power Responses for Piezoelectric generator Module with  $R=580K\Omega$ ,  $C=750pF$

Compare to the parallel type piezo electric module with series type piezo electric module, parallel type piezo electric module converting more power by Table VIII. &Table VI.

**B. Electric Output Power Of The Piezo Electric Generator**

The dependence of the electric output power of the device on the load resistance to determine the maximum output. Figure.13 shows the module of piezo electric generator. Table IX shows the converted output power for different load values.

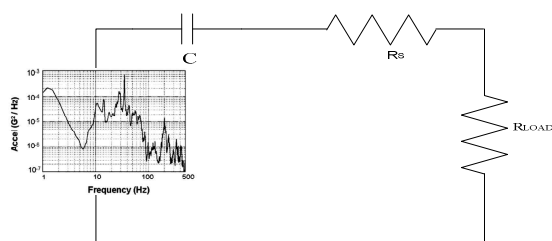

Fig.13: Piezo Electric Generator Module

TABLE IX COMPARISON OF VARIOUS  $R_L$  VALUES WITH MAXIMUM VALUE

$R_L$ values	Maximum values of (1 to 100)HZ		Maximum values of (1 to 10)HZ	
	Frequency	Power(pico watts)	Frequency	Power (pico watts)
580KΩ	99	21	8	13
262.5KΩ	99	9.5	8	5.9
4825KΩ	99	170	8	105
6725KΩ	99	290	8	145

For the analysis of frequency range (1 to 100 Hz) the lowest power produced by resistor R1 (9.5 pico watts on 262.5 KΩ), while resistor R4 delivered the highest output power of 290pico watts on a resistive load of 6725KΩ. For the analysis of low frequency range (1 to 15 Hz), the lowest power of 5.9pico watts on a resistive load of 262.5 KΩ, while load

The electric converted power is proportional to load resistance at resonance condition means load resistance equal to source resistance equal to source resistance the generated power 21 pico watts on resistance of 580 KΩ. In the case of all 4 types the optimum load resistance is always higher than the source resistance.

**VII. CONCLUSIONS**

The piezoelectric converter is good choice for mechanical to electric energy conversion compare to remaining converters. The piezoelectric generator has the better future to provide self power to sensor nodes, army applications in soldier shoes, security and communication. In future it will give better services to every low powered electronic application.

The noises response of different type of noises are analysed by applying to various types of piezoelectric generator circuits using SIMULINK. On comparison of different noises with maximum values in the Table V- VII. It is concluded that

- Band limited white noise can used for analysis of low power range (0-2)nW of power, when coil1, 2. (0-0.08)W power ,when coil3
- Gaussian and Rayleigh noise generators used for analysis of medium power range (2-3)nW of power(coil1,2), (0.09-0.15)W power(coil3)
- Rician noise generator can be used for analysis of high power range (3-7)nW of power (0.15-0.25)W

The basic piezoelectric generator is analysed with various load values in physical view range of pressure on the piezoelectric transducer. By increasing the value of pressure, the power developed also increases the values are shown in Table IX and graphical representation shown in Figure. 14. The analysis presents useful facts which will be helpful in practice implementation.

#### REFERENCES

- [1] ShashankPriya, “Advances in energy harvesting using low profile piezoelectric transducers”, *J Electroceram*19:165–182, 2007.
- [2] “Energy Harvesting for No-Power Embedded Systems”, Adrian Valenzuela ,*Texas instruments*, October 28,2008.
- [3] C.B. Williams, R.B. Yates, in *The 8th International Conference on Solid-state Sensors and Actuators, and Eurosensors IX*, Stockholm, Sweden, pp. 369–372,1995
- [4] Zhang P., Sadler C. M., Lyon S. A., and Martonosi M., “Hardware design experiences in zebranet”,*2nd ACM conference on embedded networked sensorsystems (SenSys '04)*, Baltimore, MD, USA, Nov 3-4 2004
- [5] Klimiec E., Zaraska W., Zaraska K., Gąsiorowski K. P., Sadowski T and Pajda M., “Piezoelectric polymer films as power converters for human powered electronics”. *Microelectronics Reliability*, 48(6), pp. 897-901, 2008.
- [6] Rocha J. G, Goncalves L. M, Rocha P. F, Silva M. P. and Lanceros-Méndez S., “Energy harvesting from piezoelectric materials fully integrated in footwear”. *IEEE Trans. Ind. Electron.*, 57(3), pp. 813-819, 2010.
- [7] Ramusrikakulapu., “ Some aspects of energy harvesting and use of acoustic vibrations”, M.Tech thesis, 2012, NIT Kurukshetra.